

Mercedes

- G-Modell
- B-Klasse
- M-Klasse
- SLK
- E-Klasse
- Sprinter Mittel (nur Alternativpunkte möglich)
- SmartFortwo 3rd Gen
- Sprinter Lang 4325mm Radst. (*)
- smart
- R-Klasse
- CLK
- Vito
- S-Klasse lang

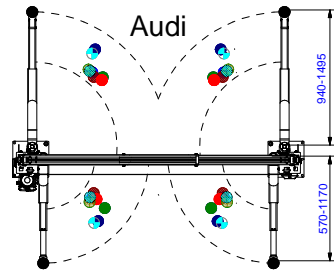

Audi

- Audi Q7
- Audi Q5
- Audi A5
- Audi A2
- Audi A3 (2004)
- Audi TT
- Audi A8 lang
- Audi R8*

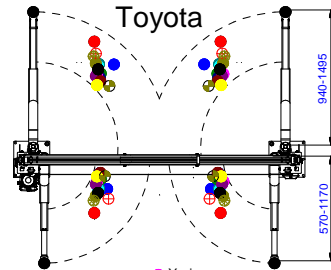

Toyota

- Cressida
- Toyota IQ (**)
- Land Cruiser (GX-R)
- RAV 4
- Corolla 1988-1991
- Echo (2000)
- Hiace (kurz)
- Yaris
- MX-81/MX-83 1989-1992
- Crown
- Toyota Yaris (2000)
- Corolla ab 2004
- XA seit 2004
- Avenis
- Camry
- Landcruiser

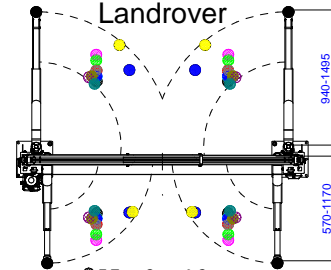

Jaguar Landrover

- F-Type Conv. & Coupe
- XJL (Long Wheel Base)
- XF
- XK
- XJ
- XE
- New XF
- F-Pace
- Range Rover LWB
- Evogue L538
- Defender 110
- Discovery 4 (**)

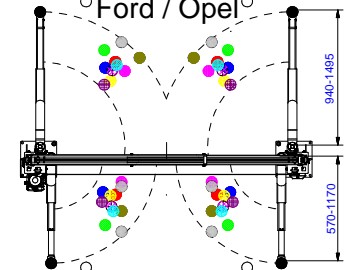

Ford / Opel

- Ford Fiesta
- Ford Mondeo
- Ford Explorer
- Ford Maverik
- Ford Transit (2013) (*)
- Dodge Ram 1500/2500 Bj.09/18 (**)
- Opel Agila
- Opel Corsa
- Opel Vectra Combi 2007
- Opel Insignia
- Opel Vivaro ab 2014

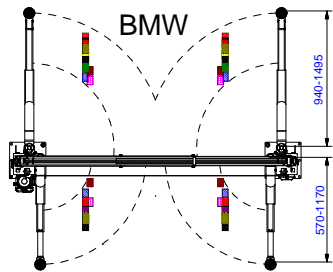

BMW

- G05/G06 (BMW X5/X6)
- G07 (BMW X7)
- G29/J29 (BMW Z4)
- F49 (BMW X1 Langversion China)
- F39 (BMW X2)
- G01/G02 (BMW X3/X4)
- G08 (BMW X3 Langversion)
- G20/G21 (BMW 3-er Touring)
- G31/G32 (BMW 5-er Touring / 6er GT)
- G14/G15 (BMW 8-er Cabrio / Grad Coupé M)
- F91/92/93/G16 (BMW X3/X4)

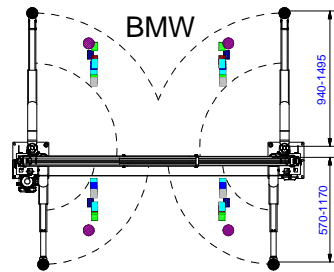

BMW

- F52 (BMW 1er Stufenheck (China))
- F40 (BMW 1er)
- F46 (BMW 2er Grand Tourer)
- F35 (BMW 3er Langversion (China))
- F60 (Mini Countryman)
- RR11 (Rolls Royce Phantom)
- RR12 (Rolls Royce Phantom EWB)
- RR31 (Rolls Royce Cullinan)
- G12 (Langversion 7er)

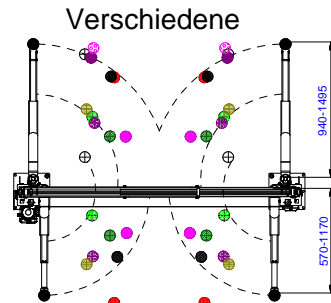

Verschiedene

- Renault Megane II (**)
- Nissan GTR (**)
- Peugeot 207 SW
- Peugeot Boxer lang (*)
- Fiat 500
- Landrover Defender 110 300 TDI
- LS600
- Citroen Jumper, Radstand 4035 (*)
- Dodge Ram (*)
- Hyundai H350 Bj. 2015
- Touran
- Phaeton
- Touareg / Cayenne
- VW T4 kurz
- VW T5/T6 kurz
- VW T5/T6 lang (**)
- Seat Leon / Altea
- Seat Toledo
- Crafter mittel Bj. 2017, Radst. 3640 (**)
- Crafter L4 Bj. 2016 F/Q+4x4 (*)
- VW Golf 7

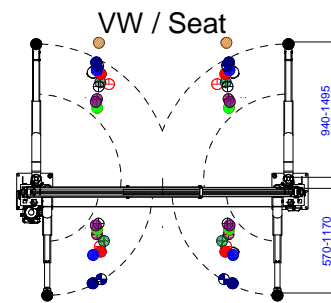

VW / Seat

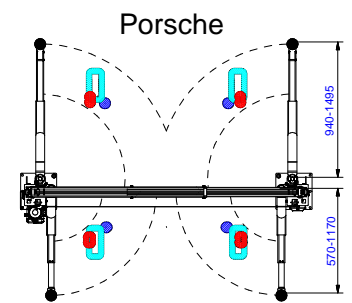

Porsche

- Porsche SUV
- Porsche Sportwagen
- Porsche Limousine

Alle Maße in mm! / all dimensions in mm!
Mass- und Konstruktionsänderungen vorbehalten! DIMENSION and design changes reserved!

Tragfähigkeit: 3500kg
capacity: 3500kg

235SLH00004 (3D CAD-Modell)				Projektionsmethode 1 ISO 5456-2		Benennung / designation		
-	-	-	-	Datum	Name	2.35 SLH DT		
-	-	-	-	Bearb.	08.09.2022			MH
-	-	-	-	Gepr.				
						Aufnahmematrix		
						Zeichnungsnummer / drawing number		
				Korker Str. 24, 77694 Kehl www.nussbaumlifts.com		9168_NB		
ind.	Aender. / modification	Datum	Name					

(*) Fahrzeug kann nicht aufgenommen werden
(**) Fahrzeug muss genau positioniert werden