







COMPANY WITH
QUALITY SYSTEM
CERTIFIED BY DNV GL
= ISO 9001 =

SMONTAGOMME PER SERVIZIO MOBILE E OFFICINA 

TYRE CHANGER FOR ROAD-SIDE AND WORKSHOP SERVICE 

MONTIERGERÄT FÜR DEN MOBILEN ODER STATIONÄREN EINSATZ 

DÉMONTE-PNEUS POUR SERVICE MOBILE OU EN ATELIER 

DESMONTADORA PARA SERVICIO MÓVIL O EN EL TALLER 

GRS926

Smontagomme autocarro per servizio mobile o in officina, adatta a furgoni telonati o piccole officine.

Truck tyre changer for both road-side and workshop service, suitable for closed vans and/or small workshops.

Montiergerät für den mobilen oder stationären Einsatz, geeignet für geschlossene Anhänger oder Kleinwerkstätte.

Démonte-pneus PL pour service mobile ou en atelier. Il adapte aux fourgons bâchés ou pour petits ateliers.

Desmontadora para camiones para servicio móvil o para servicio en el taller, ideal para furgonetas con toldo carrozadas o pequeños talleres.



INCLUDES TOOL FOR TUBE TYRES



FULL SIZE HYDRAULIC CLAMPING UNIT

GRS926

Mandrino idraulico. Adatta anche a pneumatici agricoli.
Hydraulic chucking table. Suitable also for agricultural tyres.
Hydraulische Spannvorrichtung. Geeignet auch für Landwirtschaftsräder.
Mandrill hydraulique. Apte aussi au pneus agricoles.
Plato mandril hidráulico. Puede ser utilizada con ruedas agrícolas también.



MOBILE SERVICE



EASY SETTING



COMPACT



MINIMUM HEIGHT
330 mm (13")
MINIMUM CLAMPING
Ø 90 mm (3,5")

ERGONOMIC



Sliding plate for wheel loading

SUPER SINGLE



Extension for extra large tyres



QUICK DEMOUNTING



QUICK MOUNTING



GRS926

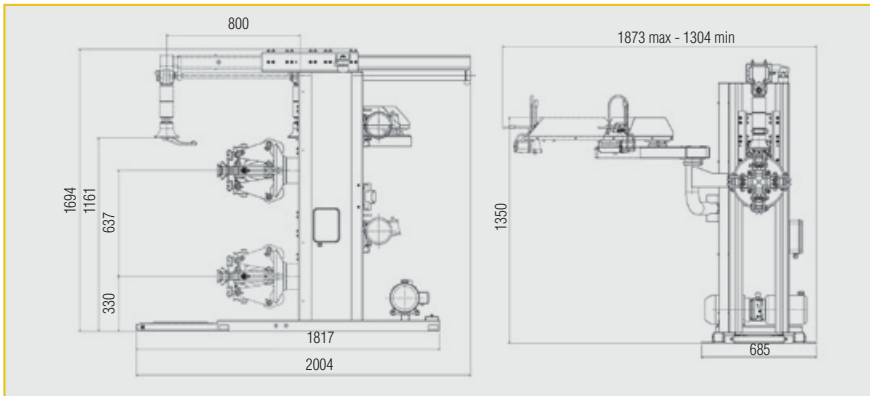

OPTIONS

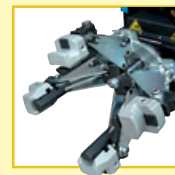

G108A2
 ALU PROTECTION
 (4 x kit)



G90A6
 ALU RIM CLAMP



G108A22
 DISC FOR WHEELS
 WITH LOCK RING

| DATI TECNICI | TECHNICAL DATA | TECHNISCHE DATEN | DONNEES TECHNIQUES | DATOS TÉCNICOS | GRS926 |
|---|--------------------------------|--|---|---|-------------------------|
| Motore rotazione mandrino | Chucking unit rotation motor | Motor für Drehung der Spannvorrichtung | Moteur rotation mandrin | Motor rotación plato | 1,1 kW |
| Motore centralina | Hydraulic drive unit motor | Hydraulikmotor | Moteur de la pompe | Motor unidad hidráulica | 2 kW |
| Ø cerchi | Rim Ø | Felgen-Ø | Ø de la jante | Ø de llantas | 11"-27" |
| Ø est. ruota ammesso | Max. wheel Ø | Raddurchmesser | Ø de la roue | Ø maximo ext. rueda | 1300 mm (51") |
| Larghezza max. ruota | Max. allowed wheel width | Max. Radbreite | Largeur maxi de la roue | Ancho max. rueda | 950 mm (37.4") |
| Peso | Weight | Gewicht | Poids | Peso | 378 kg/833 lb |
| Potenza stallonatore | Bead breaker power | Abdrückerkraft | Force du détalonneur | Force du détalonneur | 16000 N |
| Peso max ruota | Max wheel weight | Maximales Radgewicht | Poids maxi de la roue | Poids maxi de la roue | 1200 kg/2645 lbs |
| Velocità di rotazione mandrino (giri/min) | Chuck rotation speed (rev/min) | Sperrvorrichtung-Drehgeschwindigkeit (U./min.) | Vitesse de rotation du mandrin (tours/min.) | Velocidad de rotación mandril (rev./min.) | 8 |
| Coppia max al mandrino | Max. torque to chuck | Max. Sperrvorrichtung-Drehmoment | Couple max. au mandrin | Par máx al mandril | 1700 Nm (1253 FtLbs) |

Ravaglioli



Ravaglioli S.p.A.
 via 1° maggio 3
 Fraz. Pontecchio M.
 40037 Sasso Marconi (Bo) - Italia
 Tel. +39 - 051 - 6781511
 Fax +39 - 051 - 846349
 rav@ravaglioli.com
 www.ravaglioli.com

RAV France
 4, Rue Longue Raie
 ZAC de la Tremblaise
 91220 Le Plessis Pâté
 Tel. 01.60.86.88.16
 Fax 01.60.86.82.04
 rav@ravfrance.fr

Ravaglioli Deutschland
 Kirchenpoint 22
 85354 Freising
 Tel. 08165-646956
 Fax 08165-646958
 ravd@ravaglioli.com

RAV Equipment UK LTD
 Prince Albert House
 20 King Street
 Maidenhead, SL6 1DT
 Tel. +39 - 0516781522
 rav@ravaglioli.com

RAV en Belgique
 Nederlandstalig
 Tel. 0498-162016
 Fax 016-781025
 Zone Francophone
 Tel. 0498-163016
 Fax +32 78 055 030

RAV Equipos España S.L.U.
 Avenida Europa 17
 Pol. Ind. de Constanti
 Tarragona 43120
 Tel. 977 524525
 Fax 977 524532
 ravequipos@ravaglioli.e.telefonica.net

A DOVER COMPANY

DRN29U (07)

